

SXE10 3S-GE - Engine Control Electrical Parts Location

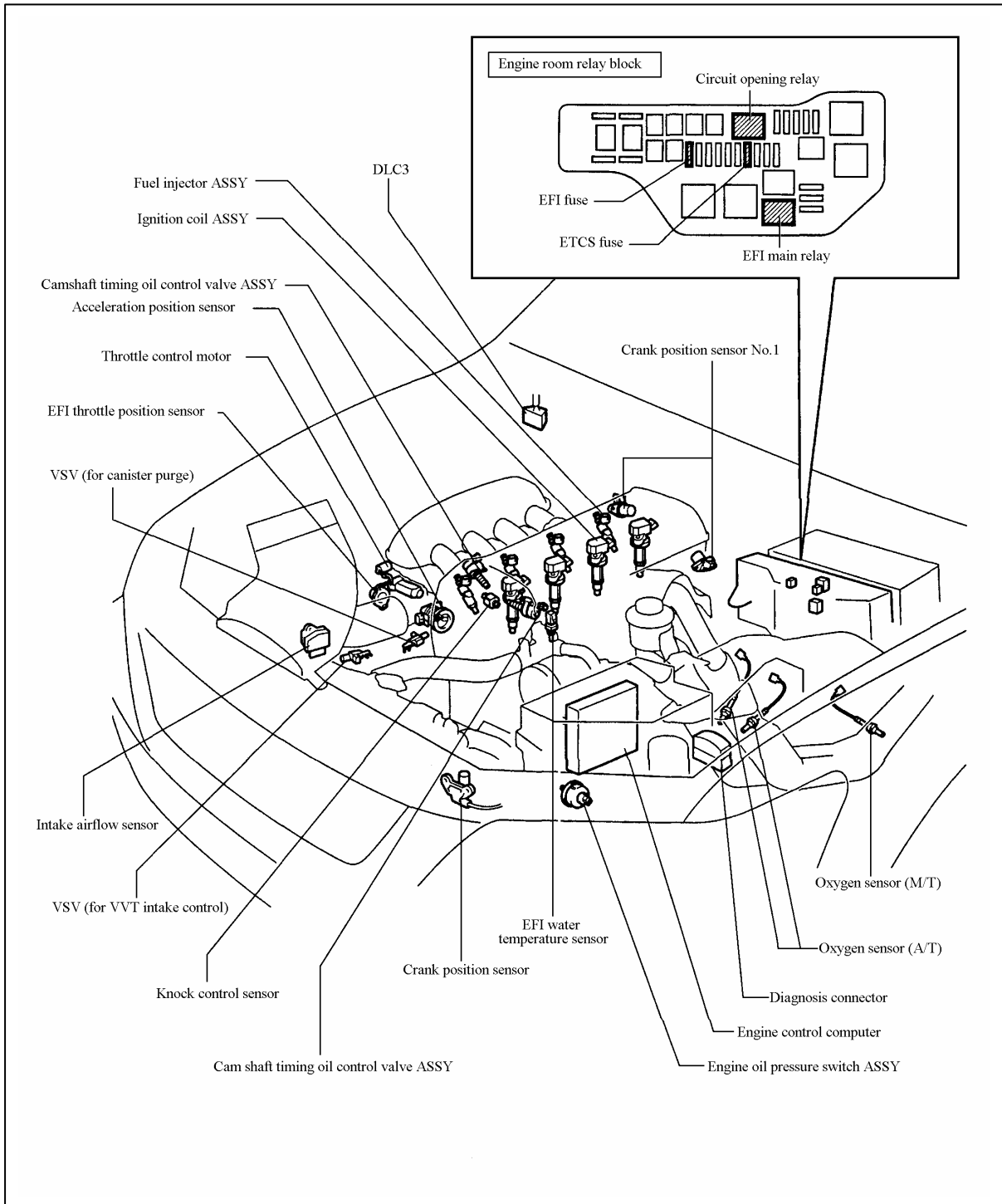

SXE10 3S-GE – Summary Engine Control Electrical Wiring Diagram

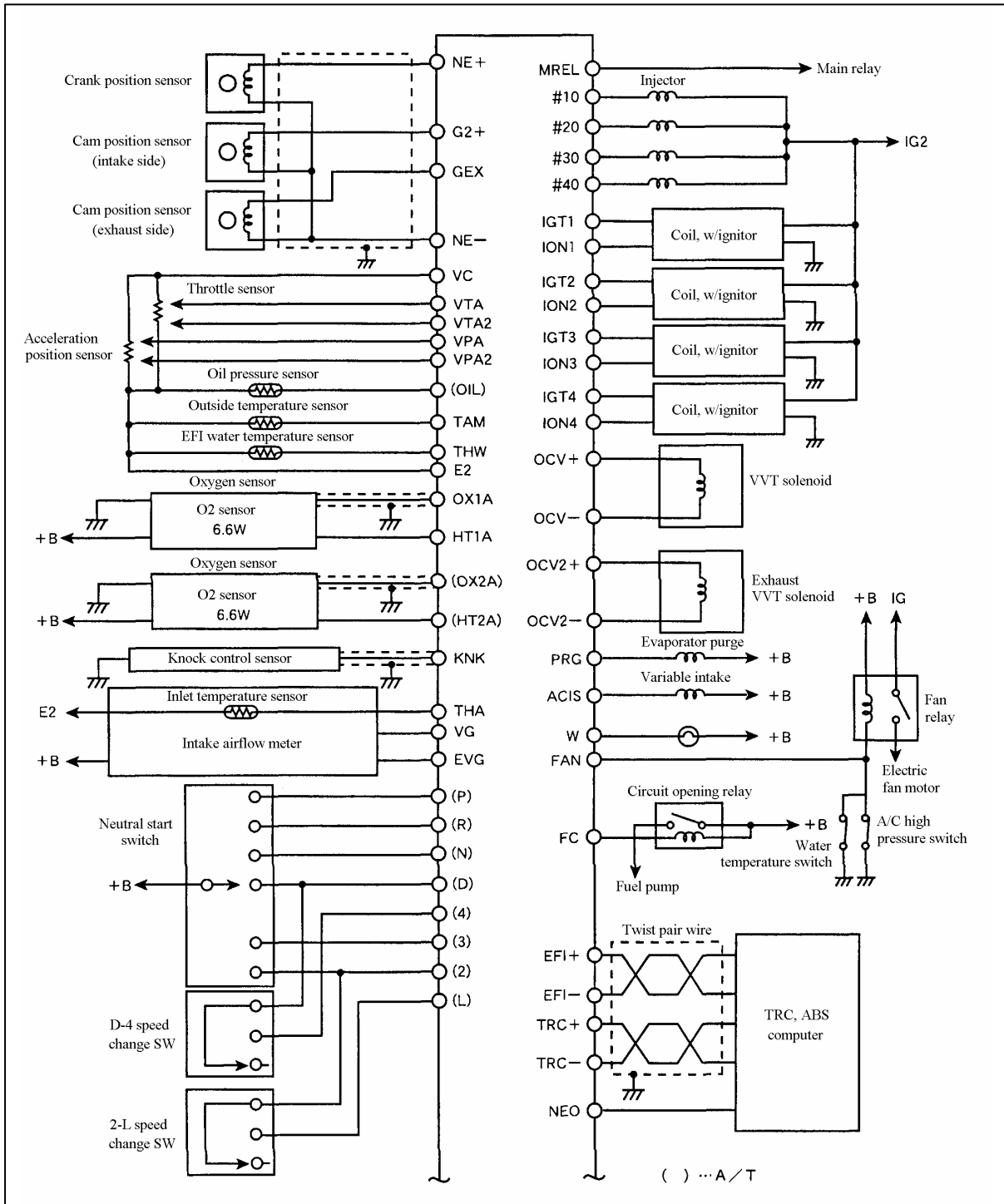

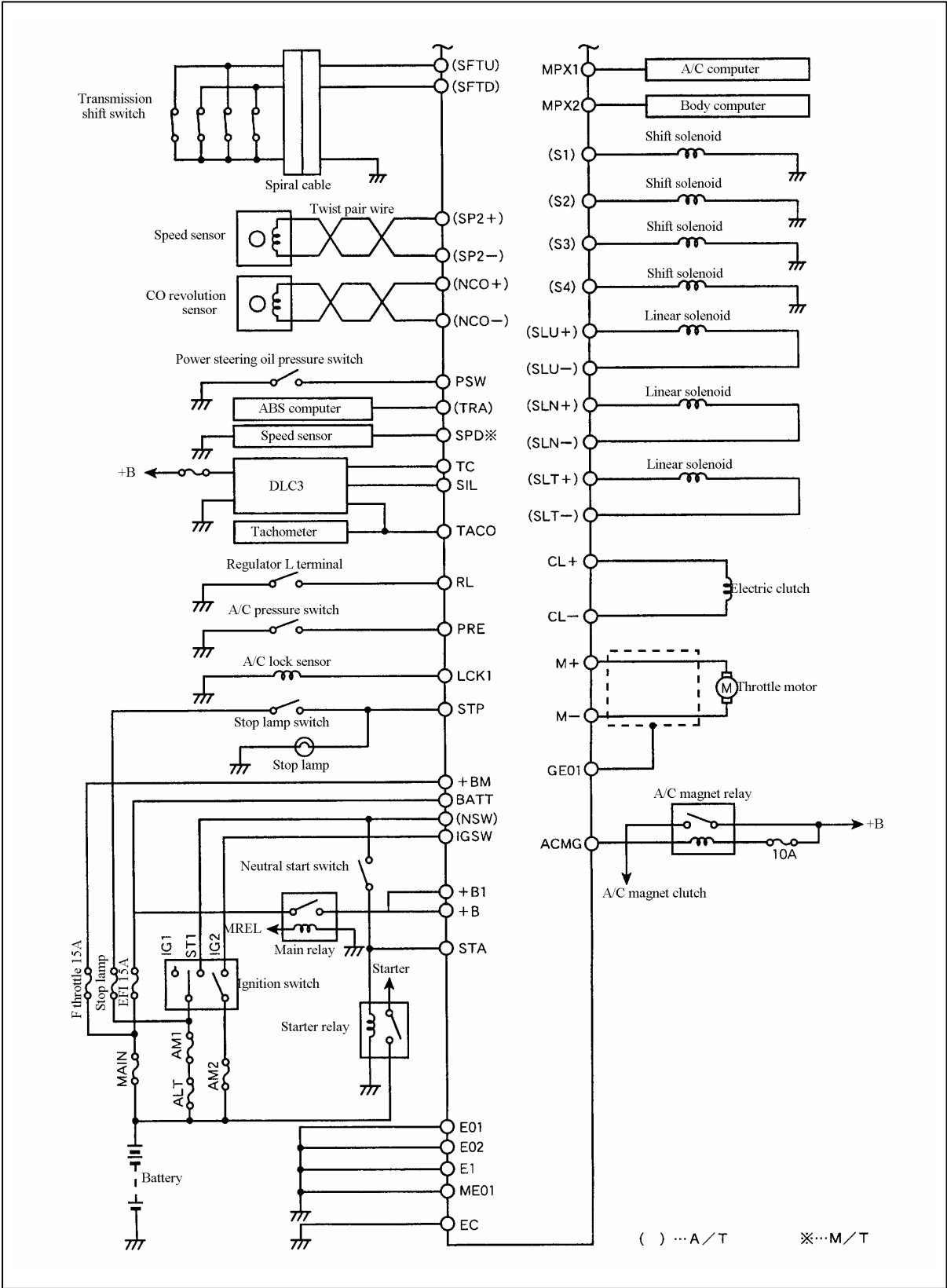

SXE10 3S-GE – Engine Control ECU Pin Configuration

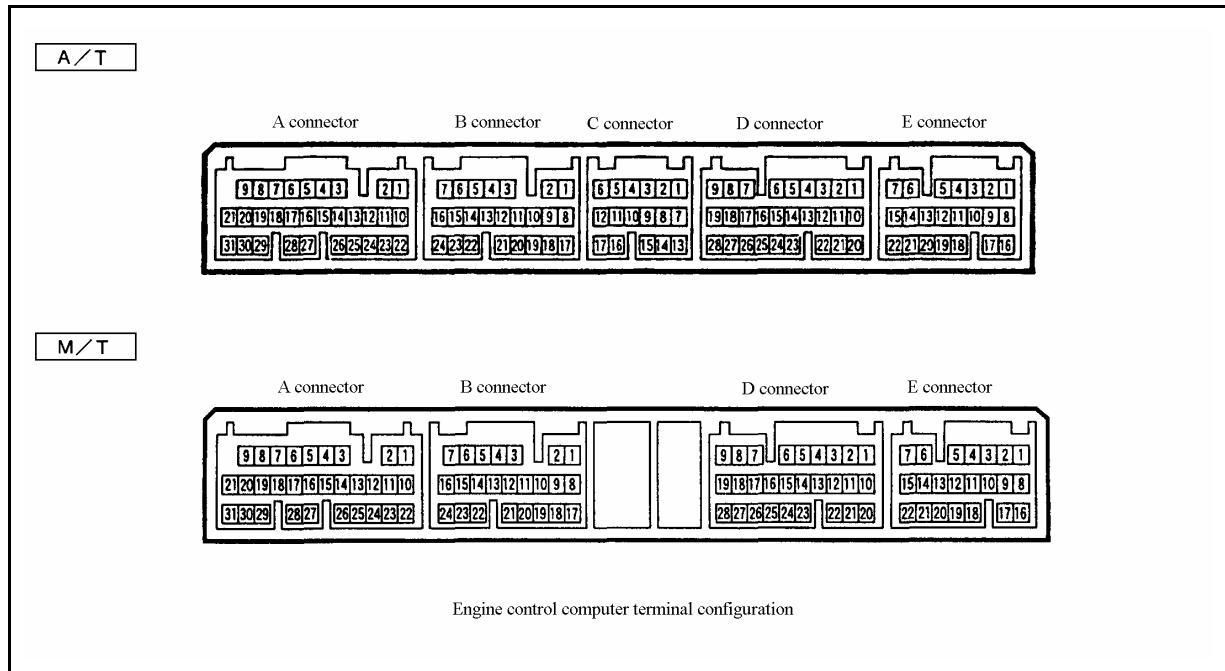

Engine control computer terminal configuration

Inspection Item	Terminal (Terminal No.)	Input / Output	Condition	Standard [V]
Power	+B1 (E8) ? E1 (B17) +B (E16) ? E1 (B17) IGSW (E10) ? E1 (B17) +BM (A6) ? E1 (B17)	Input	Engine stopped, IG ON	9~14
Power	BATT (E1) ? E1 (B17)	Input	Always	9~14
Power	VC (B2) ? E1 (B17)	Output	Engine stopped, IG ON	4.5~5.5
Ignition signal	IGT (A10) ? E1 (B17) IGT2 (A11) ? E1 (B17) IGT3 (A12) ? E1 (B17) IGT4 (A13) ? E1 (B17)	Output	After warmed up, while idling	Waveform 1
Ignition signal	ION1 (B9) ? E1 (B17) ION2 (B10) ? E1 (B17) ION3 (B11) ? E1 (B17) ION4 (B16) ? E1 (B17)	Input	After warmed up, while idling	Waveform 1
Revolution signal	GEX (B14) ? NE- (B24) G2+ (B15) ? NE- (B24) NE+ (B15) ? NE1 (B24)	Input	After warmed up, while idling	Waveform 2
Injection signal	#10 (A1) ? E1 (B17) #20 (A2) ? E1 (B17) #30 (A3) ? E1 (B17) #40 (A4) ? E1 (B17)	Output	After warmed up, while idling	Waveform 3

Variable intake control VSV	ACIS (A5) ? E1 (B17)	Output	Idling ? throttle opening angle 30° or more and engine revolution 2500rpm or more OR 1000rpm or less (variable intake control VSV ON)	0~3
Variable intake control VSV	ACIS (A5) ? E1 (B17)	Output	Engine stopped, IG ON (variable intake control VSV OFF)	9~14
Canister purge VSV	PRG (A7) ? E1 (B17)	Output	Purge VSV ON	0~3
Canister purge VSV	PRG (A7) ? E1 (B17)	Output	Purge VSV OFF	9~14
Power steering pressure switch	PSW (A15) ? E1 (B17)	Input	With turning steering wheel, confirm ON signal	0~0.5
Power steering pressure switch	PSW (A15) ? E1 (B17)	Input	With turning steering wheel, confirm OFF signal	9~14
Inlet temperature sensor	THA (A16) ? E1 (B17)	Input	Inlet air temperature 0~80°C (when warm up)	0.5~3.4
Water temperature sensor	THW (A17) ? E1 (B17)	Input	Coolant temperature 60~120°C (when warm up)	0.2~1.0
Throttle motor	M+ (A19) ? E1 (B17)	Output	After warmed up, while idling	Waveform 4
Throttle motor	M- (A29) ? E1 (B17)	Output	After warmed up, while idling	Waveform 5
Throttle motor clutch	CL+ (A20) ? E1 (B17)	Output	After warmed up, while idling	Waveform 6
Regulator output	RL (A22) ? E1 (B17)	Input	While idling	0~3
Regulator output	RL (A22) ? E1 (B17)	Input	Engine stopped, IG ON	9~14
Knock sensor output	KNK (A27) ? E1 (B17)	Input	After warmed up, maintain engine revolution at 4000rpm	Waveform 7
Oxygen sensor	OX1A (A28) ? E1 (B17)	Input	After warmed up, main engine revolution at 2500rpm and hold it for 2 minutes	Waveform 8
Oxygen sensor (A/T)	OX2A (D10) ? E1 (B27)	Input	After warmed up, main engine revolution at 2500rpm and hold it for 2 minutes	Waveform 8
Airflow meter	VG (B21) ? EVG (B1)	Input	While idling, A/C OFF	1.0~1.5
Oxygen sensor heater	HT1A (B3) ? E1 (B17)	Output	While idling	0~3
Oxygen sensor heater (A/T)	HT2A (D11) ? E1 (B17)	Output	Engine stopped, IG ON	9~14

VVT signal	OCV+ (B5) ? OCV- (B4)	Output	After warmed up, while idling	Waveform 9
VVT signal	OCV2+ (B7) ? OCV2- (B6)	Output	After warmed up, while idling	Waveform 9
Air conditioner lock	LCK1 (B8) ? E1 (B17)	Input	Air conditioner ON (magnet clutch ON)	Waveform 10
Throttle position sensor	VTA (B23) ? E1 (B17)	Input	Engine stopped, IG ON (released accelerator pedal)	0.4~1.0
Throttle position sensor	VTA (B23) ? E1 (B17)	Input	Engine stopped, IG ON (depressed accelerator pedal)	3.2~4.8
Throttle position sensor	VTA2 (B22) ? E1 (B17)	Input	Engine stopped, IG ON (released accelerator pedal)	2.0~2.9
Throttle position sensor	VTA2 (B22) ? E1 (B17)	Input	Engine stopped, IG ON (depressed accelerator pedal)	4.7~5.1
Accelerator position sensor	VPA (B20) ? E1 (B17)	Input	Engine stopped, IG ON (released accelerator pedal)	0.3~0.9
Accelerator position sensor	VPA (B20) ? E1 (17)	Input	Engine stopped, IG ON (depressed accelerator pedal)	3.2~4.8
Accelerator position sensor	VPA2 (B19) ? E1 (B17)	Input	Engine stopped, IG ON (released accelerator pedal)	1.8~2.7
Accelerator position sensor	VPA 2 (B19) ? E1 (B17)	Input	Engine stopped, IG ON (depressed accelerator pedal)	4.7~5.1
Speed sensor (A/T)	SP2+ (C4) ? E1 (B17) SP2- (C5) ? E1 (B17)	Input	While driving vehicle at approx.20km/h	Waveform 11
Speed sensor (M/T)	SPD (D19) ? E1 (B17)	Input	While driving vehicle at approx.20km/h	Waveform 12
Air conditioner cut	AMCG (D1) ? E1 (B17)	Output	Air conditioner ON	9~14
Air conditioner cut	AMCG (D1) ? E1 (B17)	Output	On above condition, open throttle valve from fully close to fully open	0~3
Outside temperature sensor	TAM (D14) ? E1 (B17)	Input	Outside temperature 25°C	1.6~18k-ohm
VSC ECU communication	NEO (D17) ? E1 (B17)	Output	After warmed up, while idling	Waveform 13
VSC ECU communication	EFI+ (E14) ? E1 (B17) EFT- (E13) ? E1 (B17)	Output	After warmed up, while idling	Waveform 14
VSC ECU communication	TRC+ (E21) ? E1 (B17) TRC- (E20) ? E1 (B17)	Output	After warmed up, while idling	Waveform 15

Neutral start switch (A/T)	NSW (D23) ? E1 (B17)	Input	Shift position P, N range	0~3
Neutral start switch (A/T)	NSW (D23) ? E1 (B17)	Input	Shift position other than P, N range	9~14
Tachometer output	TACO (D26) ? E1 (B17)	Output	After warmed up, while idling	Waveform 16
Brake	STP (D27) ? E1 (B17)	Input	Stop lamp switch ON	7.5~14
Brake	STP (D27) ? E1 (B17)	Input	Stop lamp switch OFF	0~1.5
Starter signal	STA (D28) ? E1 (B17)	Input	While ranking	6 or more
Circuit opening relay	FC (E3) ? E1 (B17)	Output	Engine stopped, IG ON	9~14
Circuit opening relay	FC (E3) ? E1 (B17)	Output	After warmed up, while idling	0~3
Cooling fan relay	FAN (E4) ? E1 (B17)	Output	IG ON, when coolant temperature is high	9~14
Air conditioner pressure switch	PRE (E6) ? E1 (B17)	Input	Air conditioner ON (magnet clutch ON)	0~1.5
Air conditioner pressure switch	PRE (E6) ? E1 (B17)	Input	Air conditioner OFF (magnet clutch OFF)	7.5~14
Check engine warning	W (E7) ? E1 (B17)	Output	Disconnect water temperature connector (when check engine warning lamp ON)	0~3
Check engine warning	W (E7) ? E1 (B17)	Output	While idling (when check engine warning lamp OFF)	9~14
EFI main relay	MREL (E22) ? E1 (B17)	Output	Engine stopped, IG ON	0~3
EFI main relay	MREL (E22) ? E1 (B17)	Output	IG OFF	0~3
Body multiplex communication	MPX1 (E5) ? E1 (B17) MPX2 (E12) ? E1 (B17)	Input	After warmed up, while idling	Waveform 17
Diagnosis communication	SIL (E11) ? E1 (B17)	Input/ Output	While connected S2000 tester with DLC3 connector	Waveform 18
ABS communication (A/T)	TRA (E17) ? E1 (B17)	Input	Engine stopped, IG ON	Waveform 19
Test terminal	TC (D24) ? E1 (B17)	Input	Engine stopped, IG ON	9~14
Test terminal	TC (D24) ? E1 (B17)	Input	When connected TC and CG of DLC3 connector	0~3

Earth	E1 (B17) ? body earth E2 (B18) ? body earth E01 (A21) ? body earth E02 (A31) ? body earth EC (E15) ? body earth ME01 (A8) ? body earth GE01 (A9) ? body earth	Earth	(inspection of continuity)	(always continuity)
-------	---	-------	----------------------------	---------------------

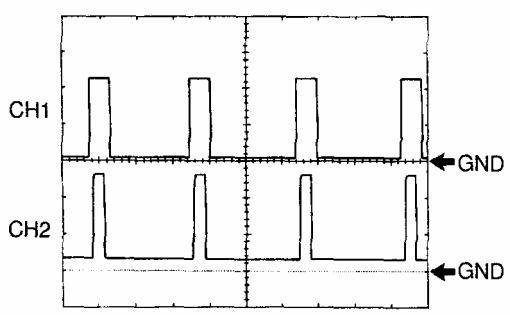
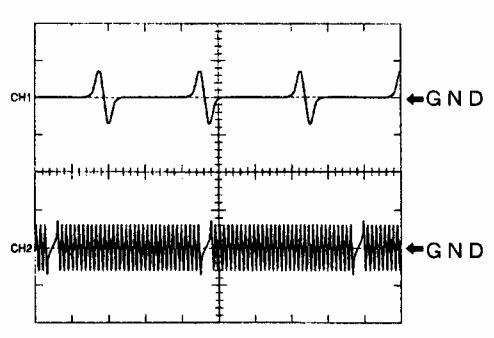
Waveform	Description
	<p>Waveform 1</p> <p><Reference></p> <ul style="list-style-type: none"> • Inspection terminal CH1: IGT1, IGT2, IGT3, IGT4 ? E1 • Inspection terminal CH2: ION1, ION2, ION3, ION4 ? E1 • Gauge set: 2V/DIV, 10ms/DIV • Inspection condition: After warmed up, while idling <p><Note></p> <p>Waveform cycle become shorter when engine revolution is increasing.</p>
	<p>Waveform 2</p> <p><Reference></p> <ul style="list-style-type: none"> • Inspection terminal CH1: G2+, GEX ? NE- • Inspection terminal CH2: NE+ ? NE- • Gauge set: 2V/DIV, 20ms/DIV • Inspection condition: After warmed up, while idling <p><Note></p> <p>When engine revolution is increasing;</p> <ul style="list-style-type: none"> • Waveform cycle become shorter • Amplitude become large.

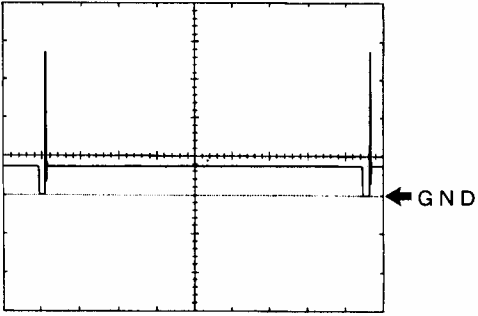
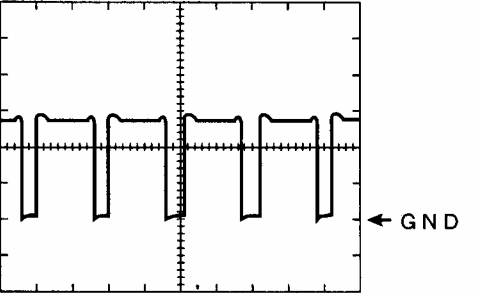
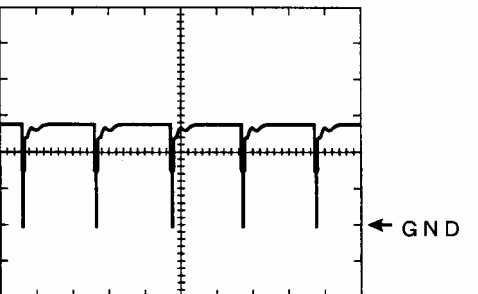
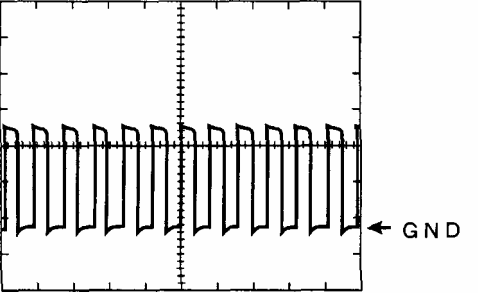
	<p>Waveform 3</p> <p><Reference></p> <ul style="list-style-type: none"> • Inspection terminal: #10, #20, #30, #40 ? E1 • Gauge set: 20V/DIV, 20ms/DIV • Inspection condition: After warmed up, while idling <p><Note></p> <p>Waveform cycle become shorter when engine revolution is increasing.</p>
	<p>Waveform 4</p> <p><Reference></p> <p>Inspection terminal: M+ ? E1</p> <p>Gauge set: 5V/DIV, 1ms/DIV</p> <p>Inspection condition: After warmed up, while idling</p> <p><Note></p> <p>Waveform cycle changes depending on throttle opening position</p>
	<p>Waveform 5</p> <p><Reference></p> <ul style="list-style-type: none"> • Inspection terminal: M- ? E1 • Gauge set: 5V/DIV, 1ms/DIV • Inspection condition: After warmed up, while idling <p><Note></p> <p>Waveform cycle changes depending on throttle opening position</p>
	<p>Waveform 6</p> <p><Reference></p> <ul style="list-style-type: none"> • Inspection terminal: CL+ ? CL- • Gauge set: 5V/DIV, 5ms/DIV • Inspection condition: After warmed up, while idling

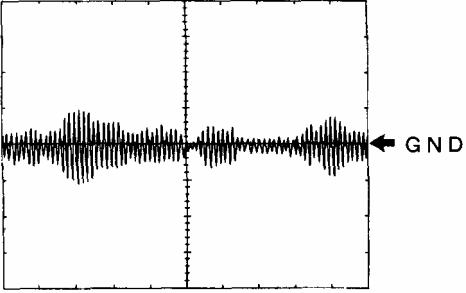
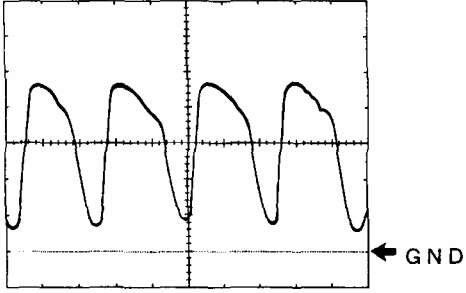
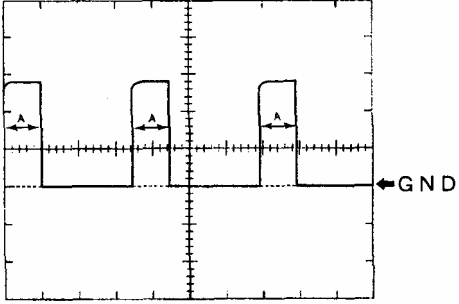
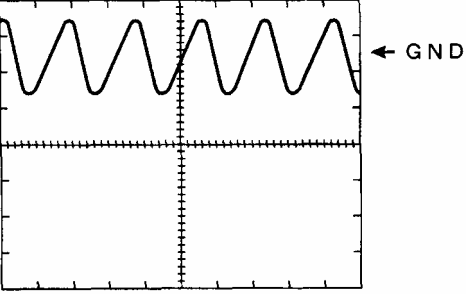
	<p>Waveform 7</p> <p><Reference></p> <p>Inspection terminal: KNK ? E1</p> <p>Gauge set: 0.5V/DIV, 1ms/DIV</p> <p>Inspection condition: After warmed up, maintain engine speed at 4000rpm</p> <p><Note></p> <ul style="list-style-type: none"> • Amplitude become large when engine revolution is increasing. • Waveform height may vary depending on vehicle.
	<p>Waveform 8</p> <ul style="list-style-type: none"> • <Reference> • Inspection terminal: OX1A ? E1 • Inspection terminal: OX2A ? E1 (A/T) • Gauge set: 0.2V/DIV, 0.5s/DIV • Inspection condition: After warmed up, maintain engine revolution at 2500rpm • Inspection condition: Holt it for 2 minutes
	<p>Waveform 9</p> <ul style="list-style-type: none"> • <Reference> • Inspection terminal: OCV+ ? OVC- • Inspection terminal: OCV2+ ? OCV2- • Gauge set: 5V/DIV, 1ms/DIV • Inspection condition: After warmed up, while idling <p><Note></p> <p>A become shorter when engine revolution is increasing.</p>
	<p>Waveform 10</p> <p><Reference></p> <ul style="list-style-type: none"> • Inspection terminal: LCK1 ? E1 • Gauge set: 10V/DIV, 10ms/DIV • Inspection condition: A/C compressor ON

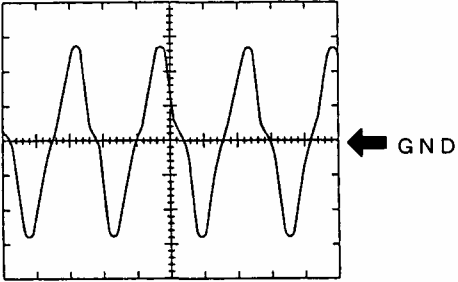
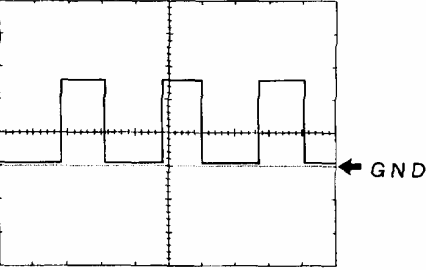
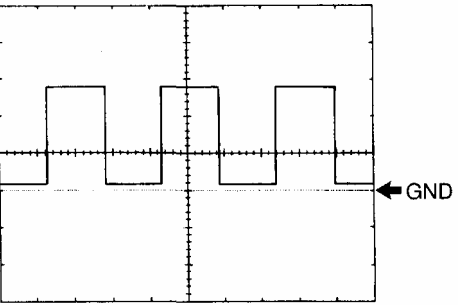
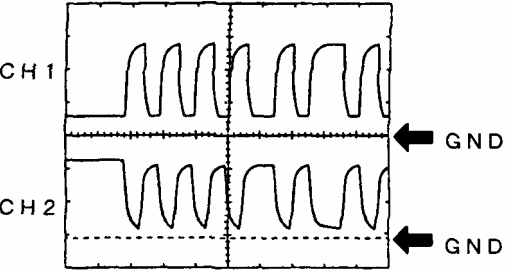
	<p>Waveform 11 (A/T)</p> <p><Reference></p> <ul style="list-style-type: none"> • Inspection terminal: SP2+, SP2- ? E1 • Gauge set: 20mV/DIV, 2ms/DIV • Inspection condition: While driving vehicle at 20km/h. <p><Note></p> <p>When engine revolution is increasing;</p> <ul style="list-style-type: none"> • Waveform cycle become shorter • Amplitude become large.
	<p>Waveform 12 (M/T)</p> <p><Reference></p> <p>Inspection terminal: SPD ? E-</p> <p>Gauge set: 5V/DIV, 20ms/DIV</p> <p>Inspection condition: While driving vehicle at 20km/h</p> <p><Note></p> <p>Waveform cycle become shorter when engine revolution is increasing.</p>
	<p>Waveform 13</p> <p><Reference></p> <p>Inspection terminal: NEO ? E1</p> <p>Gauge set: 5V/DIV, 2ms/DIV</p> <p>Inspection condition: After warmed up, while idling</p> <ul style="list-style-type: none"> • Inserted diagram is corrected output waveform • 1 pulse occurs on each 30°CA <p><Note></p> <p>Waveform cycle become shorter when engine revolution is increasing.</p>
	<p>Waveform 14</p> <p><Reference></p> <ul style="list-style-type: none"> • Inspection terminal: EFI+, EFI- ? E1 • Gauge set: 1V/DIV, 0.2ms/DIV • Inspection condition: After warmed up, while idling

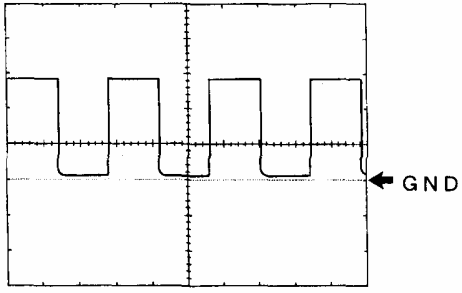
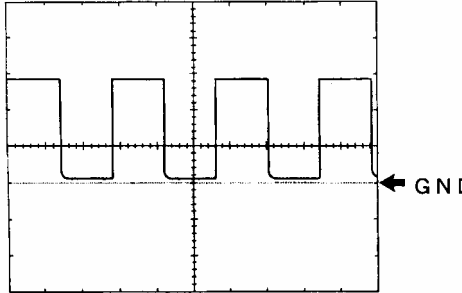
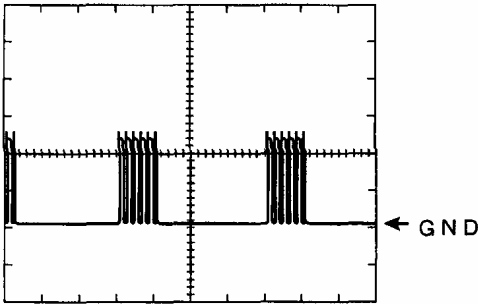
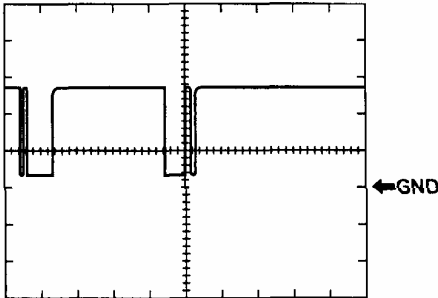
	<p>Waveform 15</p> <p><Reference></p> <ul style="list-style-type: none"> • Inspection terminal: TRC+, TRC- ? E1 • Gauge set: 5V/DIV, 10ms/DIV • Inspection condition: After warmed up, while idling <p><Note></p> <p>Waveform cycle become shorter when engine revolution is increasing.</p>
	<p>Waveform 16</p> <p><Reference></p> <ul style="list-style-type: none"> • Inspection terminal: TACO ? E1 • Gauge set: 5V/DIV, 10ms/DIV • Inspection condition: After warmed up, while idling <p><Note></p> <p>Waveform cycle become shorter when engine revolution is increasing.</p>
	<p>Waveform 17</p> <p><Reference></p> <ul style="list-style-type: none"> • Inspection terminal: MPX1 ? E1, MPX2 ? E1 • Gauge set: 5V/DIV, 5ms/DIV • Inspection condition: After warmed up, while idling
	<p>Waveform 18</p> <p><Reference></p> <ul style="list-style-type: none"> • Inspection terminal: SIL ? E1 • Gauge set: 5V/DIV, 1ms/DIV • Inspection condition: Connected S2000 tester and while communicating

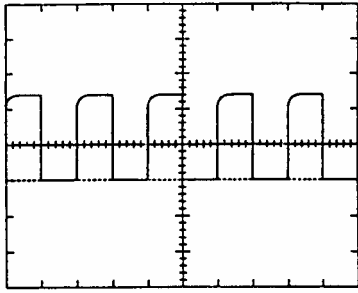

GND

Waveform 19

- <Reference>
Inspection terminal: TRA ? E1
- Gauge set: 2V/DIV, 2ms/DIV
- Inspection condition: Engine stopped, IG ON